



Célula procariota



BIOLOGIA CÉLULAR

* ¿Qué son las células procariotas?

* *ADN y ARN no está limitado por membrana nuclear*

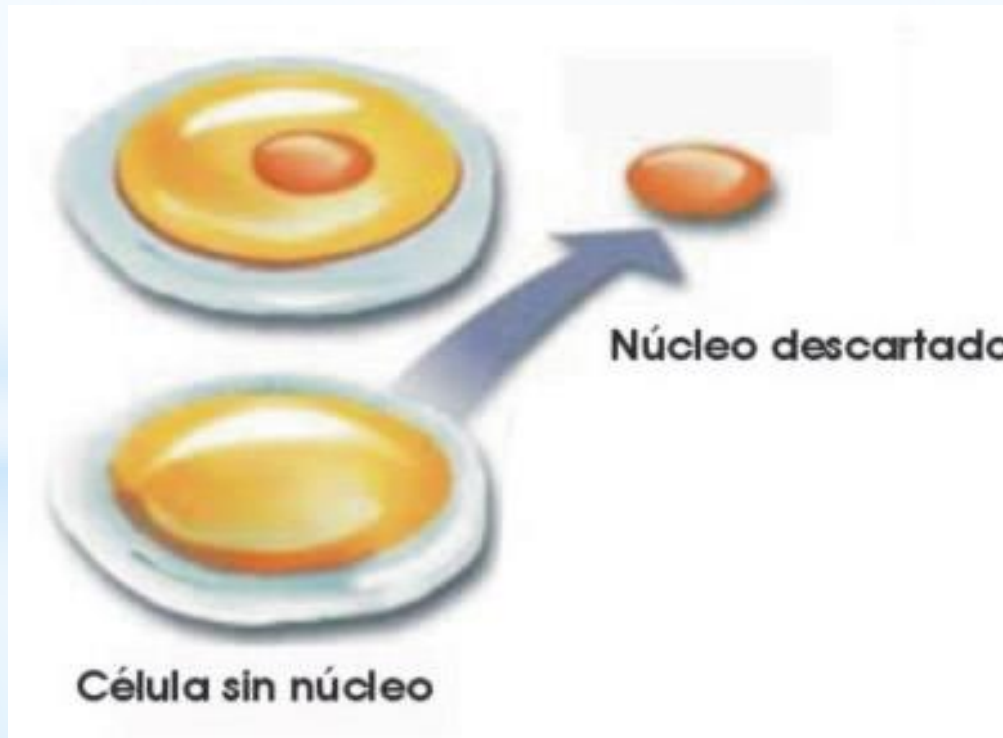

* Diferencias entre célula procariota y célula eucariota

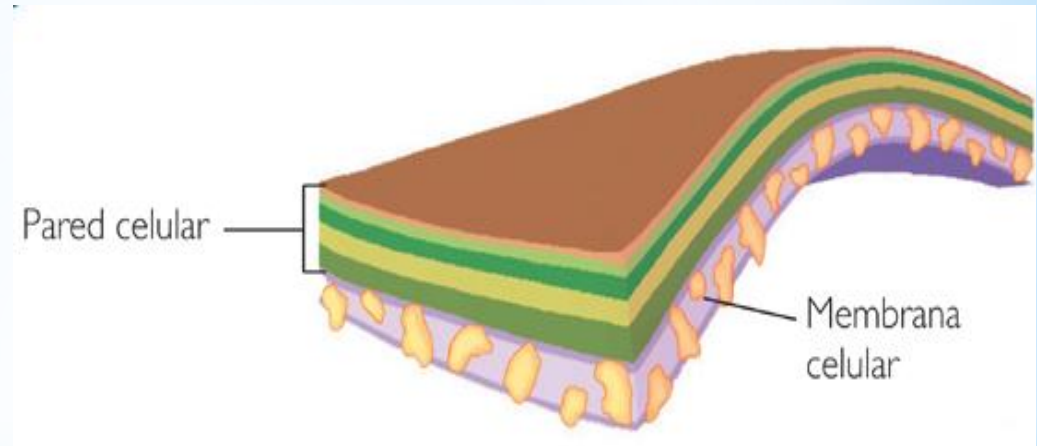
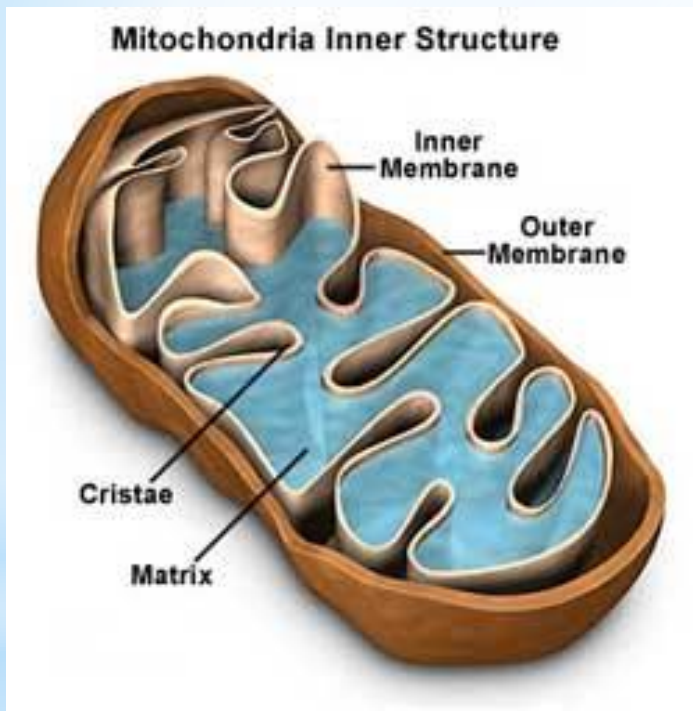

Estructura de la célula procariota

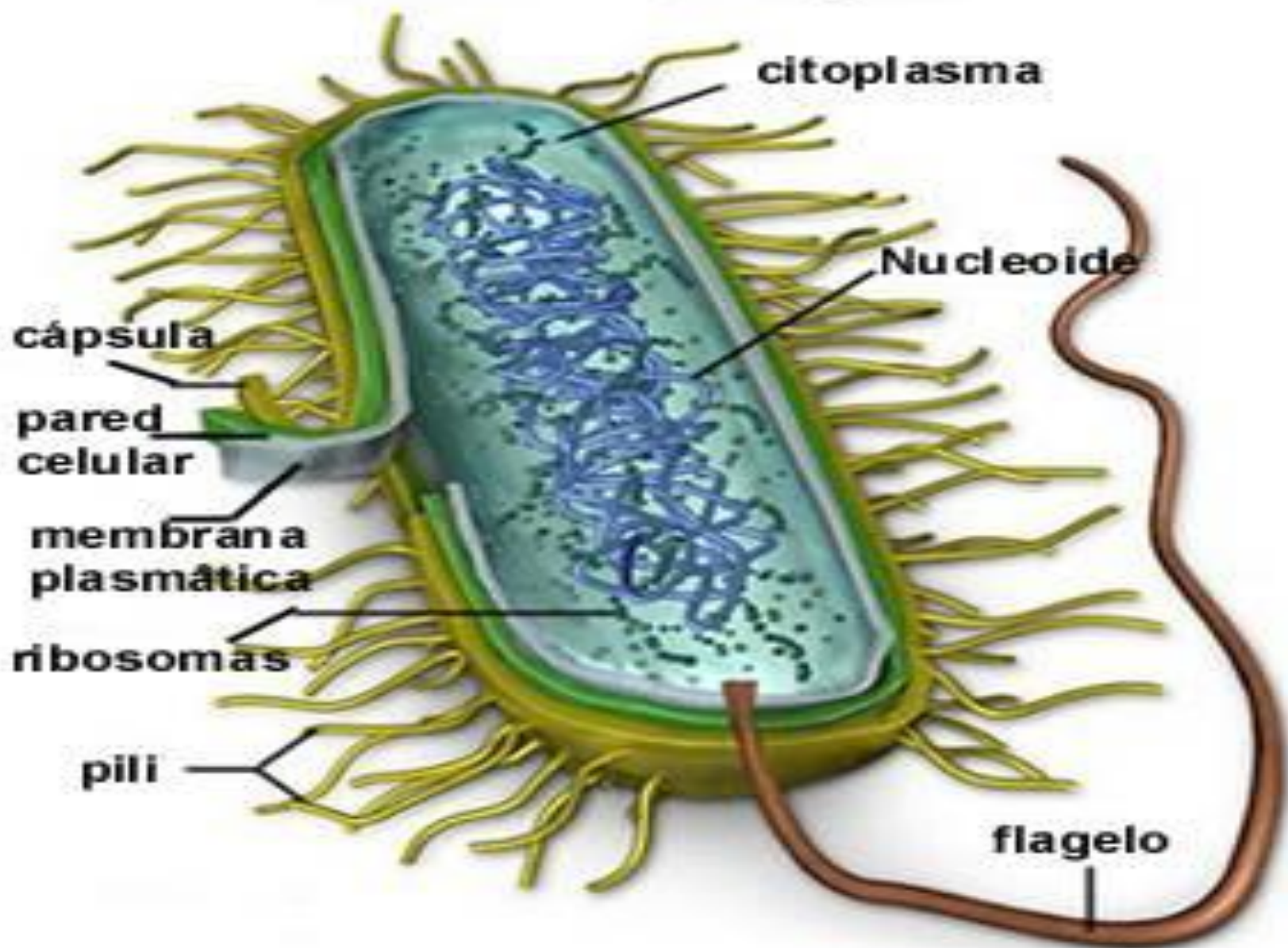

Tipos de procariotas

Según la envoltura celular

Gracilicutes (A)

Firmicutes (B)

Mendosicutes (C)

Tenericutes (D)

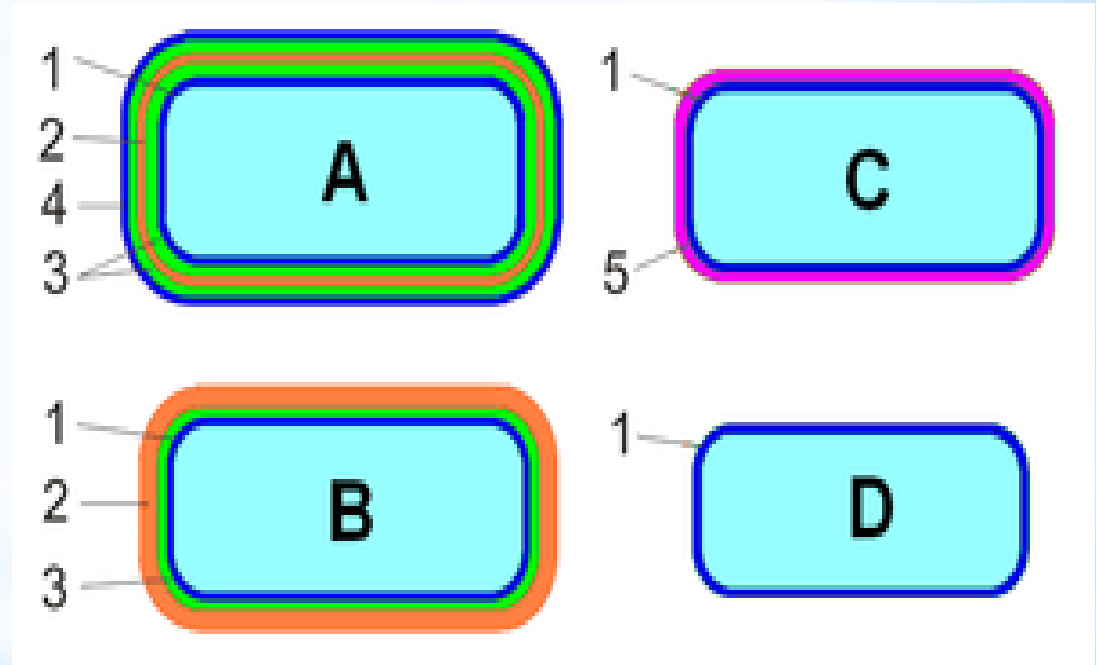

Según el sistema de los tres dominios

Archaea

- Metanógenos
- Halófilas
- Hipertermófilas





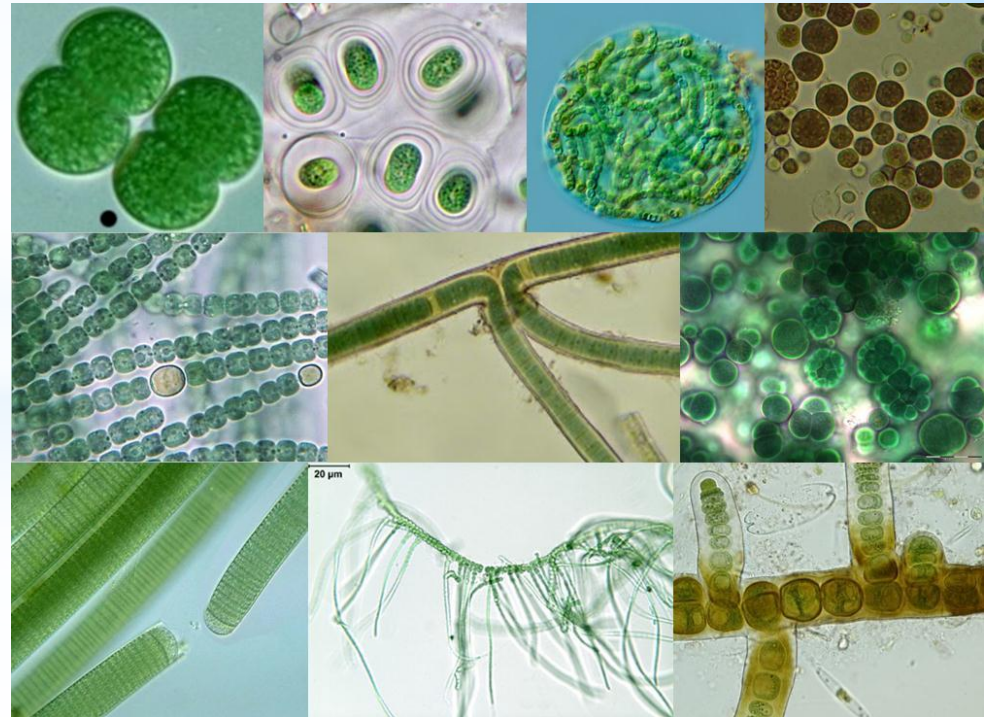
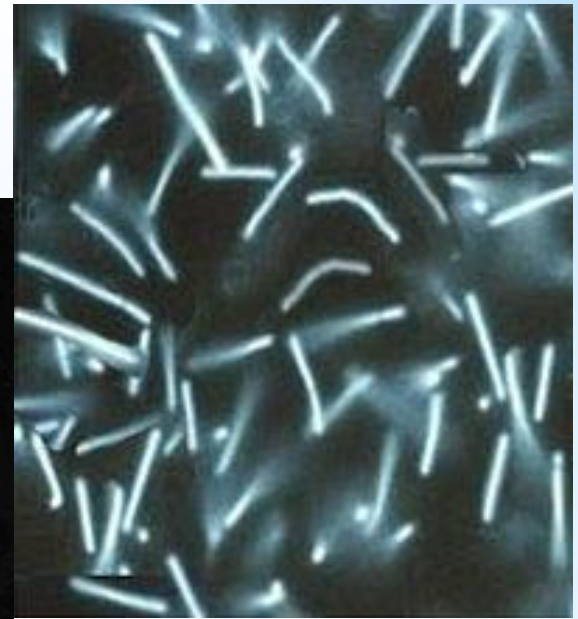

Bacteria

- Cianobacterias





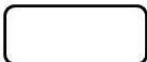



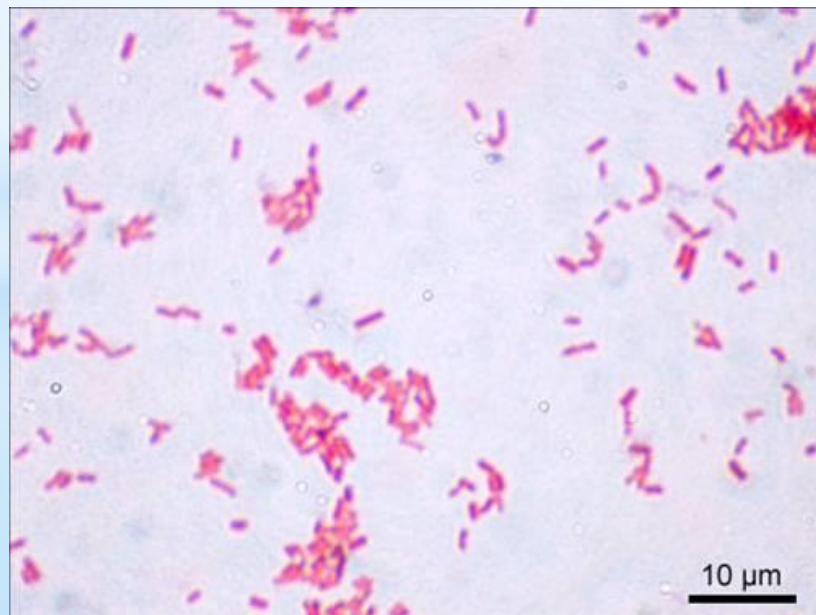
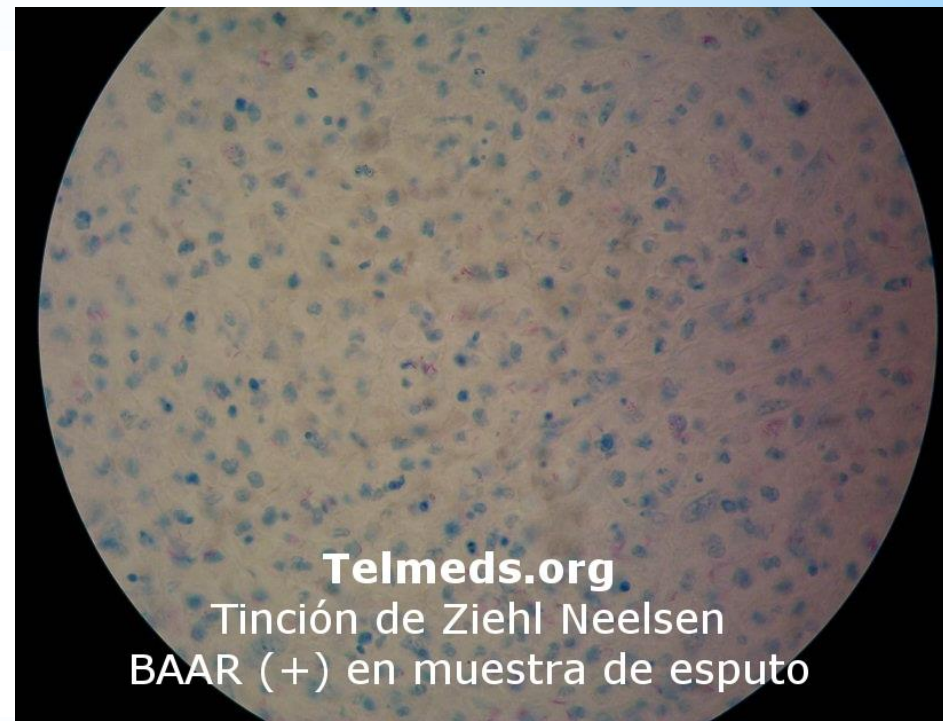



Tinciones

TINCIÓN DE ZIEHL-NEELENSEN

AAR +	Pasos	AAR -
	Fijación	
	Colorante principal: fuchina	
	Decoloración: alcohol/HCl	
	Colorante de contraste: Azul de metileno	



TINCIÓN DE GRAM

Gram +	Pasos	Gram -
	Fijación	
	Colorante principal: cristal violeta	
	Mordiente: Iugol	
	Decoloración: alcohol/acetona	
	Colorante de contraste: safranina	

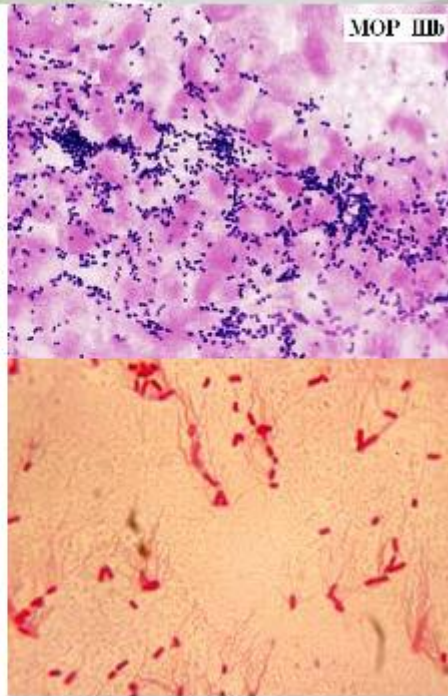

MOP 11b

Membrana plasmática

Pared celular

Bacteria Gram positiva

Membrana plasmática

Pared celular

Membrana externa

Bacteria Gram negativa

Cocos Gram positivo



Cocos Gram negativo

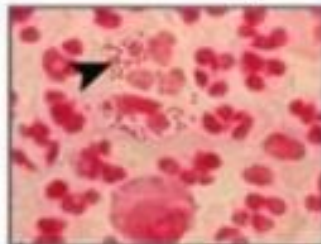

Bacilos Gram positivo

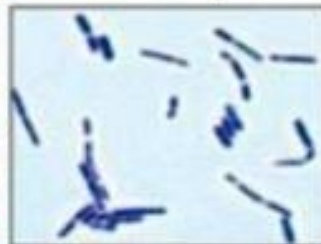

Bacilos Gram negativo



El color y la forma de las células sirven de ayuda para clasificar el tipo de bacterias presentes.
Usado con el permiso de AAFP-PT.

*Referencias

- * *célula procariota*. (mayo de 2005). Obtenido de <http://celulabhill.galeon.com/enlaces1218266.html>
- * Hernández, B. (1 de Junio de 2012). *Análisis a Cárnicos*. Obtenido de <http:// analisisaproductoscarnicos.blogspot.mx/2012/06/tinciones-utilizadas-en-microbiologia.html>
- * Orozco, D. (3 de Noviembre de 2014). *definición de bacteria*. Obtenido de <http://conceptodefinicion.de/bacteria/>